

COLLEZIONE DIVANI

WILD
STILE LIBERO
MARGOT

Sofa Collection

SPAGNOLSALOTTI

Sofa collection

**Una collezione dedicata al living in cui
design e artigianalità 100% made in Italy si incontrano
per dare forma al comfort con stile.**

A living collection where design and
100% made in Italy artisanship meet each
other to give shape to comfort with style.

COLLEZIONE DIVANI

ita Spagnol Salotti propone una nuova collezione di divani e poltrone in cui gli elementi modulari e componibili e l'attenta qualità dei rivestimenti sono caratteri distintivi per creare uno spazio relax che si adatta con stile ad ogni ambiente ed esigenza.

eng **Sofas collection.** Spagnol Salotti offers a new collection of sofas and armchairs in which the modular and sectional elements and the careful quality of the coverings are distinctive features to create a relaxing space that suits in style to any environment and demand.

Wild . design → 005

Stile Libero . design → 033

Margot . poltroncina → 067

Wild . design

Un design dall'eleganza sottile e un tocco di morbido comfort.

ita Wild è un divano dal carattere contemporaneo. I profili sottili della scocca continua accolgono, come in un abbraccio, i morbidi cuscini dello schienale, delle sedute e dei braccioli. Un comfort che prende forma tra note di eleganza e un equilibrio di volumi.

eng **A design with subtle elegance and soft touch of comfort.** Wild is a sofa with a contemporary character. The thin profiles of the continuous shell welcome, as in an embrace, the soft cushions of the backrest, seats and armrests. A comfort that takes shape between notes of elegance and a balance of volumes.

Wild . design

226 x 85 cm
divano 3 posti / 3-seater sofa



Wild

Modularità / Modularity

→ Divani / Sofas

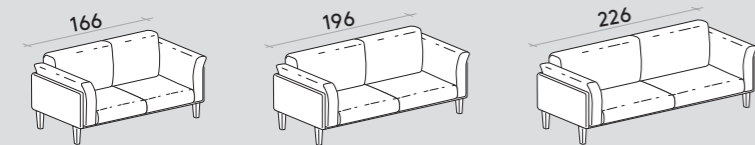
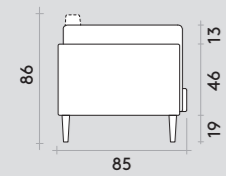

→ Poltroncina / Armchair

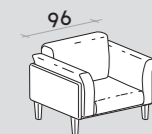

→ Angolo / Corner

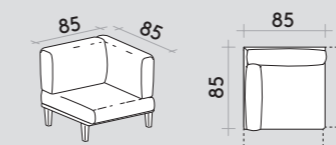

→ Lateral dx-sx / Right-left units

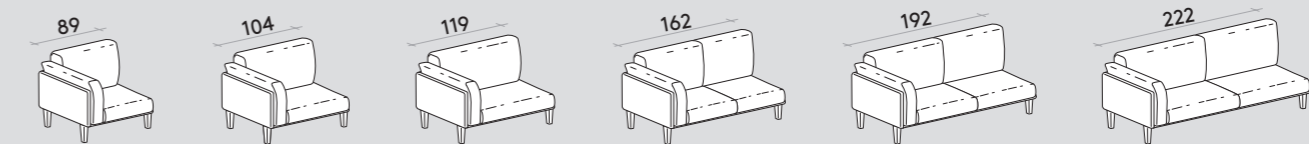

→ Penisola dx-sx / Right-left chaise

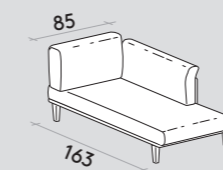

→ Dormeuse dx-sx / Right-left

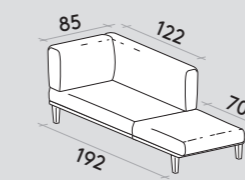

→ Pouf / Pouffe

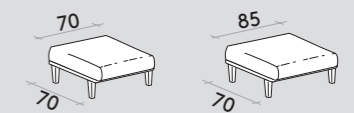

→ 01 Wild . design

226 x 85 cm
2 divani 3 posti / 2 sofa 3-seater
96 x 85 cm
2 poltrone / 2 armchairs



ARMONIOSI CONTRASTI

ita Anche nella versione poltroncina, Wild esprime il suo stile attraverso un gioco di contrasti: colori e volumi diversi si combinano armoniosamente. Proposta in abbinamento al divano, completa il comfort del living creando un perfetto angolo relax tutto per sé.

HARMONIOUS CONTRASTS

eng Also in the armchair version, Wild expresses his style through a game of contrasts: different colors and volumes get along with each other harmoniously. The proposal, in combination with the sofa, completes the living comfort by creating a perfect relaxing corner all by itself.



ita I cuscini fuoriescono per lasciare spazio alla morbidezza
mentre i piedini sottili e la base sollevata sprigionano leggerezza.

eng The cushions come out to make way
for softness whereas the thin feet and the raised
base release lightness.





→ 02 Wild . design

226 x 85 cm
divano 3 posti / 3- seater sofa
192 x 85 cm
dormeuse sx / left dormeuse
70 x 85 cm
pouf / pouffe

DESIGN ELEGANTE

ita La dormeuse è un vero invito a rilassarsi, seduti o sdraiati. Comodità e raffinatezza si esprimono attraverso i toni delicati e le forme morbide dei cuscini che sono racchiusi dal design sottile, nelle tonalità più accese del verde, della base e dei fianchi.

ELEGANT DESIGN

eng The dormeuse is a real invitation to relax, sit or lie down. Comfort and refinement are expressed through the delicate tones and soft shapes of the cushions which are surrounded by the thin design, in the brightest shades of greenery of base and sides.



→ 03 Wild . design

222 x 85 cm
divano 3 posti sx / 3-seater sofa left facing
85 x 163 cm
penisola dx / right chaise
70 x 70 cm
pouf / pouffe



ita Gli accenti di colore a contrasto dei rivestimenti esaltano la personalità di Wild rendendolo il vero protagonista dell'ambiente.

eng The contrasting color accents of the coverings intensify the personality of Wild by making it the true protagonist of the environment.



→ 04 Wild . design

222 x 85 cm
divano 3 posti sx / 3-seater sofa left facing

192 x 85 cm
dormeuse dx / right dormeuse

96 x 85 cm
2 poltrone / 2 armchairs



ita La geometria degli spazi d'appoggio: la linearità del bracciolo del divano incontra e si integra con la rotondità del tavolino.

eng The geometry of the support spaces: the straightness of the armrest of the sofa meets and integrates with the roundness of the coffee table.





→ 05 Wild . design

96 x 85 cm
2 poltrone / 2 armchairs

RIVESTIMENTI MATERICI

^{ita} L'esterno della poltrona è impreziosito da un colorato rivestimento in tessuto trapuntato che regala una piacevole sensazione alla vista e al tatto. E' un elegante invito ad accomodarsi in un ambiente dai toni raffinati per godersi un momento di relax unico.

MATERIAL COATINGS

^{eng} The outside of the armchair is embellished with a colorful quilted fabric covering that gives a pleasant sensation to the eye and touch. It is an elegant invitation to sit in an environment with refined tones to enjoy a moment of unique relaxation.



→ 06 Wild . design

192 x 85 cm
divano 2 posti maxi sx /
2 maxi seater sofa left facing

85 x 85 cm
1 angolo / 1 corner element

192 x 85 cm
divano 2 posti maxi dx /
2 maxi seater sofa righth facing



ita Una combinazione attenta di colori e tessuti veste le forme di Wild con uno stile che dialoga con i piani d'appoggio dei tavolini Teka.

eng A careful combination of colors and fabrics clothes Wild's forms with a style that interacts with the table tops of the Teka coffee tables.



Stile Libero . design

Design e funzionalità per infinite soluzioni relax.



ita Stile Libero esprime tutto il suo carattere nel nome stesso. Grazie a una varietà di elementi modulari e componibili offre molteplici soluzioni di comfort. Un design dinamico che combina volumi, geometrie e rivestimenti diversi in uno stile unico e libero.

eng **Design and functionality for unlimited relaxing solutions.** Stile Libero expresses all its character in the name itself. Thanks to a variety of modular and sectional elements, it offers several comfort solutions. A dynamic design that combines different volumes, geometries and coatings in a unique and independent style.

Stile Libero

Modularità / Modularity

→ **Bracciolo dritto**
Straight armrest

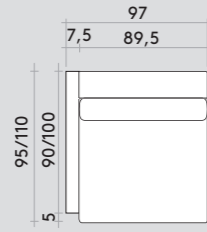

→ **Bracciolo sagomato**
Shaped armrest

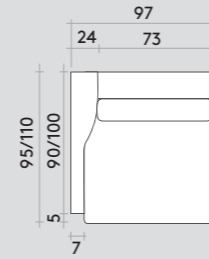

→ **Prodonfità** / Depth

P 95

P 110

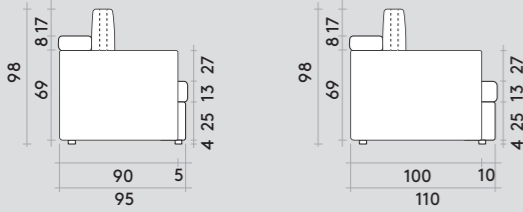

→ **Laterali dx-sx** / Right-left units

P 95

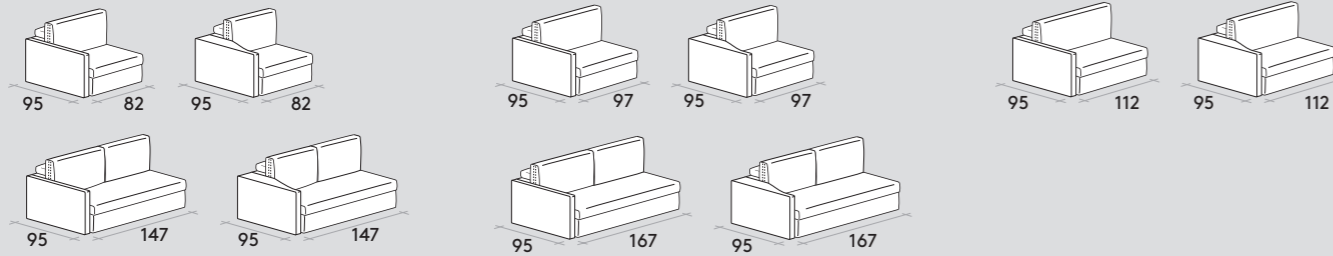

P 110

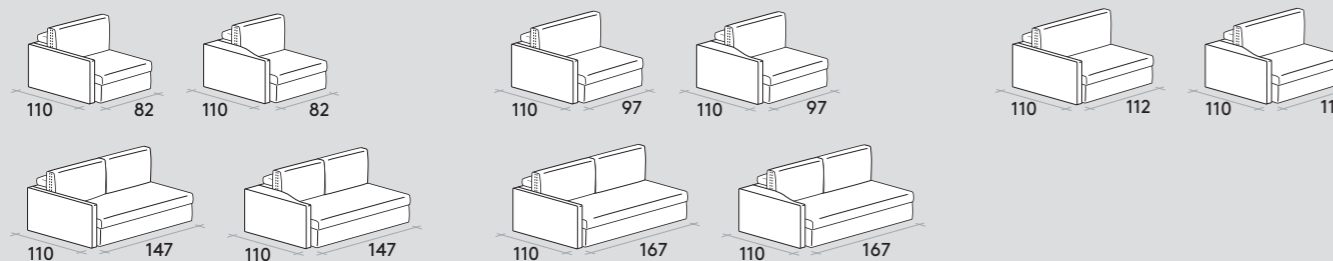

→ **Centrali** / Central

P 95

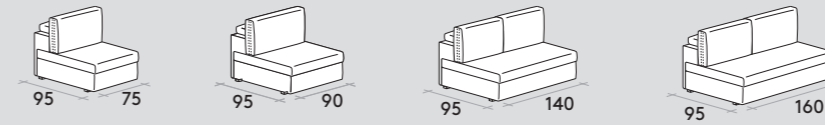

P 110

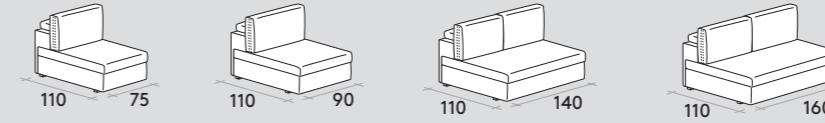

→ **Centrale obliquo** / Oblique central

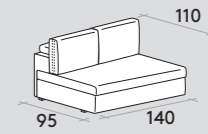

→ **Angolari dx-sx** / Right-left corner elements

P 95

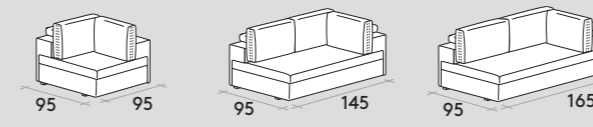

P 110

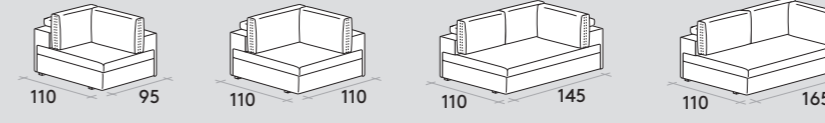

→ **Obliquo dx-sx** / Right-left oblique

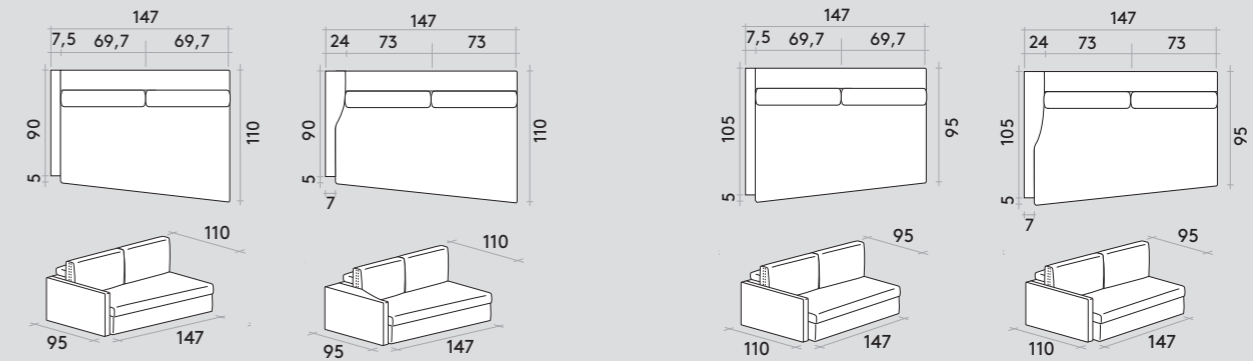

→ **Penisola** / Chaise

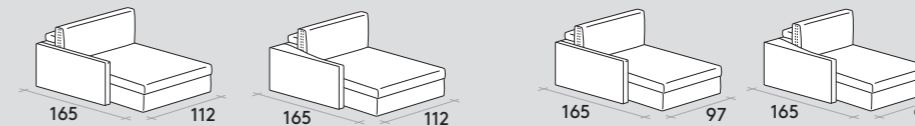

→ **Pouf** / Pouffe

P 95

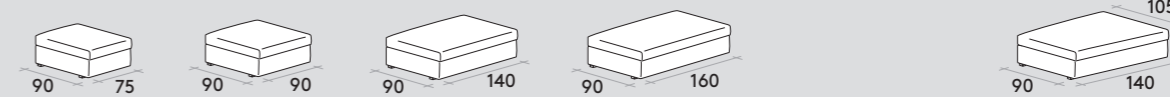

P 110

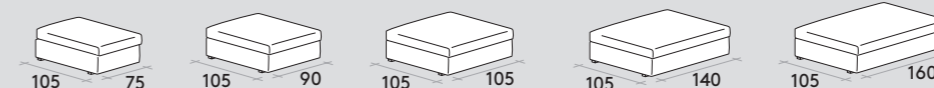

→ **Pouf obliquo** / Oblique pouffe

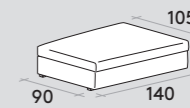



→ 01 Stile Libero . design

140 x 105 cm 4 pouf / 4 pouffe	75 x 110 cm elemento centrale / central element
105 x 105 cm pouf / pouffe	167 x 110 cm laterale dx - bracciolo sagomato / right unit - shaped armrest
165 x 110 cm angolo dx / right corner element	70 cm 3 schienali di appoggio / 3 free-standing backrests

ita Combinazioni geometriche e profondità diverse lasciano spazio alla voglia di sperimentare in libertà il proprio comfort.

eng Geometric combinations and different depths make space for the desire to freely experiment your comfort.



→ 01 Stile Libero . design

→ 02 Stile Libero . design

90 x 95 cm
elemento centrale / central element

147 x 95/110 cm
laterale obliquo sx - bracciolo sagomato /
oblique left unit - shaped armrest

147 x 95/110 cm
laterale obliquo dx - bracciolo sagomato /
oblique right unit - shaped armrest

DETTAGLI CROMATICI

ita L'inserimento del modulo obliquo spezza la linearità delle sedute ed esalta l'anima dinamica di Stile Libero. Le delicate combinazioni cromatiche di divano e cuscini portano invece una sensazione di freschezza nell'ambiente, come fosse un richiamo alla natura.

CHROMATIC DETAILS

eng The addition of the oblique module breaks the linearity of the seats and enhances the dynamic core of Stile Libero. Whereas the delicate color combinations of the sofa and cushions impart a feeling of freshness in the environment, as if it were a reference to nature.

ita Con l'aggiunta del bracciolo sagomato,
il divano Stile Libero conferisce carattere anche alla
funzionalità delle forme d'appoggio.

eng Stile Libero sofa, with the addition of
the shaped armrest, also lends character to the
functionality of the supportive forms.



RELAX VERSATILE

ita Stile Libero con la sua ampia flessibilità compositiva non arreda solo grandi spazi. La soluzione ad angolo con penisola crea una zona relax versatile, anche in spazi piccoli. Sdraiati o seduti, da soli o in compagnia, permette di vivere il proprio comfort in totale libertà.

VERSATILE RELAXATION

eng Stile Libero with its wide compositional flexibility does not just decorate large spaces. The corner solution with chaise creates a versatile relaxation area, even in small spaces. Lying or sitting, alone or in company, it allows you to live your comfort in total freedom.

→ 03 Stile Libero . design

112 x 165 cm
penisola sx - bracciolo sagomato /
left chaise - shaped armrest

167 x 95 cm
laterale dx - bracciolo sagomato /
right unit - shaped armrest

105 x 105 cm
pouf / pouffe

105 x 105 cm
pouf - schienale di appoggio L 70 cm /
pouffe - 70 cm L. free-standing backrest



ita Accostato alla penisola, il pouf con schienale regolabile aggiunge spazio alla comodità, alla convivialità e alla zona d'appoggio.

eng Matched the peninsula, the pouffe with adjustable backrest adds space to comfort, conviviality and a support area.



→ 04 Stile Libero . design

90 x 90 cm
pouf / pouffe

145 x 95 cm
angolare dx / right corner element

105 x 90 cm
pouf / pouffe

147 x 95 cm
laterale dx - bracciolo dritto /
right arm - straight armrest

160 x 105 cm
pouf centro stanza -
schienale da appoggio L 70 cm /
center room pouffe -
70 cm L. free-standing backrest



GIOCHI DI VOLUME

ita Stile Libero è anche l'eleganza di un bracciolo sottile che si allunga sottolineando la sua linearità rigorosa nelle forme, in contrasto con i volumi ampi e morbidi dei cuscini che appoggiano sullo schienale. Una composizione che sorprende in ogni angolo.

VOLUME GAMES

eng Stile Libero is also the elegance of a thin armrest that lengthens, emphasizing its rigorous linearity in its forms, in contrast with the large and soft volumes of the cushions that lean on the backrest. A composition that surprises in every corner.





CONFIGURAZIONI LIBERE

ita Stile Libero è rilassarsi in uno spazio che si lascia modellare secondo il gusto e le esigenze di chi lo vive. Una combinazione di elementi liberi dalle infinite soluzioni relax, in cui funzionalità e design soddisfano le esigenze di comfort in ogni ambiente.

UNLIMITED CONFIGURATIONS

eng Stile Libero is relaxing in a space that lets itself be modeled according to the taste and requirements of those who live it. A combination of independent elements of infinite relaxation solutions, in which functionality and design please the needs of comfort in any environment.

→ 05 Stile Libero . design

167 x 110 cm
elemento sx - bracciolo sagomato /
left element - shaped armrest

160 x 105 cm
pouf - schienale da appoggio L 70 cm /
pouffe - 70 cm L. free-standing backrest

160 x 95 cm
elemento centrale / central element

147 x 95/110
elemento obliquo dx - bracciolo sagomato /
oblique right element - shaped armrest







BRACCIOLO SAGOMATO

ita Il bracciolo sagomato è uno degli elementi che caratterizza le forme attraverso cui si esprime Stile Libero. Il suo design ergonomico diventa più sottile nella parte finale, aggiungendo alla linearità della composizione un dettaglio di leggerezza.

SHAPED ARMREST

eng The shaped armrest is one of the elements that characterizes the forms through which Stile Libero expresses itself. Its ergonomic design becomes thinner in the end, adding a lightness detail to the linearity of the composition.



→ 06 Stile Libero . design

140 x 105/95 cm
pouf obliquo sx / oblique left pouffe
75 x 95 cm
elemento centrale / central element
165 x 95 cm
angolo sx / left corner element
140 x 95 cm
elemento centrale / central element
112 x 165 cm
penisola dx - bracciolo dritto /
right chaise - straight armrest



BRACCIOLO DRITTO

ita Nella versione total white, Stile Libero è espressione di eleganza. Il bracciolo dritto rafforza il suo design dalle linee rigorose accogliendo la penisola, che allunga il comfort fino ad incontrare la funzionalità del piano d'appoggio del tavolino Happy Island.

STRAIGHT ARMREST

eng In the total white version, Stile Libero is an expression of elegance. The straight armrest strengthens its design with rigorous lines accommodating the peninsula, which extends comfort until it meets the functionality of the table top of the Happy Island coffee table.





→ Margot

poltroncina . armchair

ita La poltroncina Margot porta nell'ambiente un tocco di raffinato comfort. Forme compatte che si esprimono attraverso un equilibrio di volumi e profondità. La seduta generosa ed il morbido cuscino appoggiato allo schienale creano un angolo relax caldo e accogliente.

eng Margot armchair spreads a touch of refined comfort to the environment. Compact shapes that are expressed through a balance of volumes and depths. The abundant seat and the soft cushion leaning on the backrest create a warm and welcoming relaxing corner.

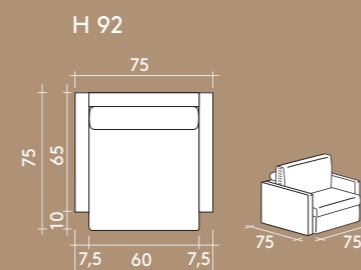

Lo stile dei complementi d'arredo completa il comfort del living.

The style of the furnishings
completes the living comfort.

TAVOLINI LIVING

ita Spagnol Salotti completa il living con l'aggiunta di complementi d'arredo. Un'ampia scelta di tavolini dal design moderno, proposti in diverse forme e misure, da abbinare ai divani e alle poltrone della collezione per rendere ancora più unico lo stile del vostro living.

eng **Living coffee tables.** Spagnol Salotti completes the living with the addition of furnishing accessories. A wide choice of tables with a modern design, proposed in different shapes and sizes, to be combined with the sofas and armchairs of the collection to make your living style even more unique.

→
Ponte . Top . Gamba Inclinata . Zippo 070

→
Rotondo . Happy Island . Teka 071

PONTE piccolo - **PONTE** grande



Ponte piccolo **L 42 x P 42 x H 40 cm**
Ponte grande **L 120 x P 60 x H 40 cm**

→ struttura - structure



→ piano - desk top

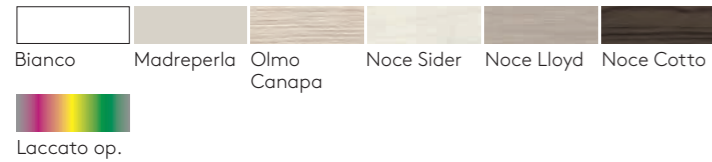

TOP



L 120 x P 60 x H 43 cm

→ gambe - legs



→ piano - desk top

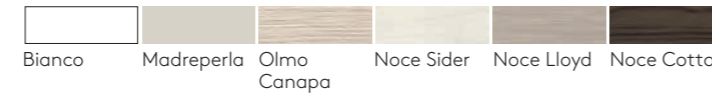

ROTONDO alto - **ROTONDO** basso



Rotondo alto **ø 45 x H 64 cm**
Rotondo basso **ø 45 x H 45 cm**

→ struttura - structure



→ piano - desk top



HAPPY ISLAND alto - **HAPPY ISLAND** basso



Rotondo alto **ø 50 x H 50 cm**
Rotondo basso **ø 50 x H 30 cm**

→ struttura - structure



→ piano - desk top



GAMBA inclinata



L 42 x P 42 x H 46 cm

→ struttura - structure



→ piano - desk top

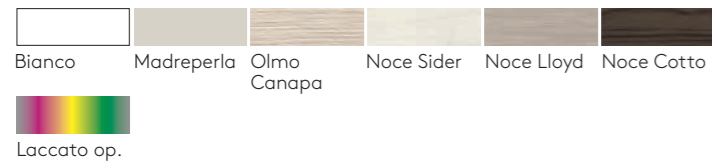

ZIPPO



L 50 x P 50 x H 33 cm
L 120 x P 70 x H 33 cm

→ struttura e piano - structure and desk top

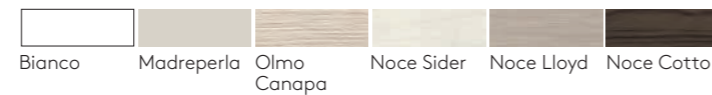

ZIPPO rotondo



ø 60 x H 45 cm
ø 90 x H 33 cm

TEKA rettangolare alto - **TEKA** rettangolare basso



Teka rett. alto **L 50 x P 40 x H 60 cm**
Teka rett. basso **L 70 x P 40 x H 40 cm**

→ struttura - structure



→ piano - desk top

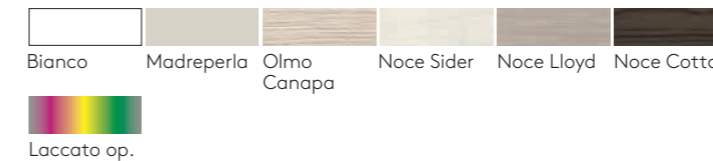

TEKA rotondo alto - **TEKA** rotondo basso



Teka rotondo alto **ø 50 x H 53 cm**
Teka rotondo basso **ø 70 x H 32 cm**

→ struttura - structure



→ piano - desk top



SPAGNOLSALOTTI

SPAGNOL MOBILI s.r.l.

Via Vidor, 2
31010 Mosnigo di Moriago
(Treviso) ITALY

Tel. +39 0438 89 11
Fax +39 0438 89 00 82
E-mail mobili@spagnolmobili.it
Web www.spagnolmobili.it

EXPORT DEPARTMENT

Tel. +39 0438 89 12 40
Fax +39 0438 89 00 82
E-mail export@spagnolmobili.it

SPAGNOLMOBILI

LAVALLE

SPAGNOLSALOTTI

VALPLANA

SPAGNOLCONTRACT



L'azienda si riserva di apportare senza preavviso modifiche tecnico-costruttive, nei materiali e nelle finiture, tali da non pregiudicare le caratteristiche essenziali del prodotto descritto o illustrato.

I colori ed i materiali rappresentati nelle immagini hanno valore indicativo in quanto soggetti alle tolleranze dei processi di stampa.

Company reserves the right to make unannounced technical and structural changes, in materials and finishes, such as not undermine the essential characteristics of the described and illustrated product. Colors and materials shown in the pictures are indicative as they are depending on the tolerances of the printing process.

